

# GM1□□55200A series

1608 Size, 0.55mm Thickness,  
Thin Type Leadless Chip LED

### ■ Outline Dimensions

(Unit : mm)

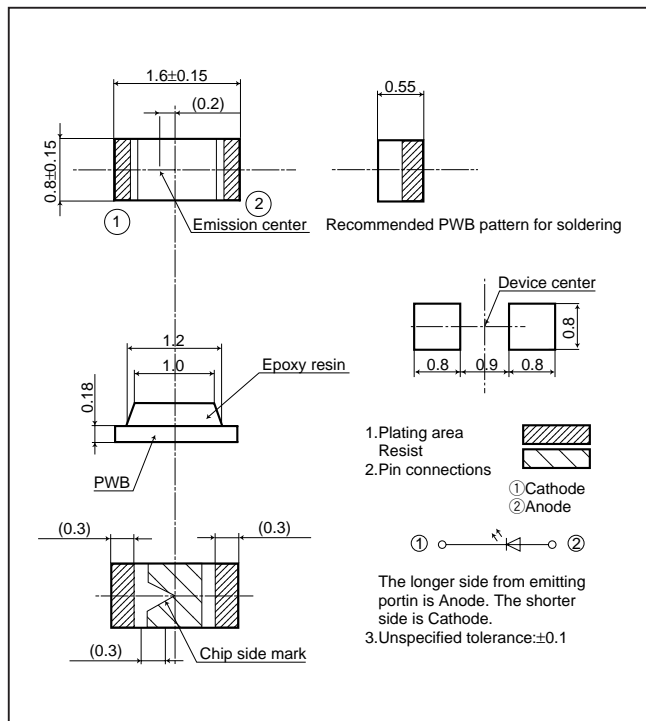

GM1UR55200A: Polarity faces in the opposite direction

### ■ Radiation Diagram

(Ta=25°C)

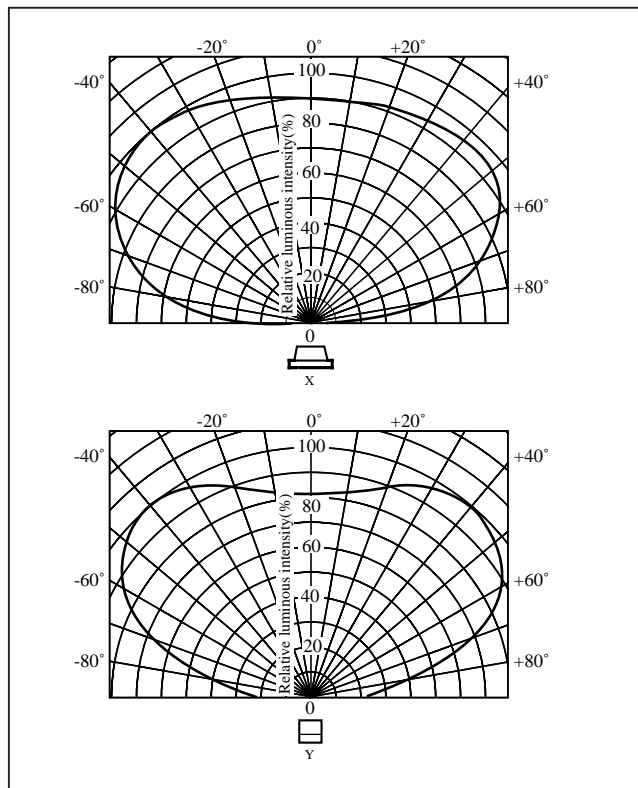

### ■ Absolute Maximum Ratings

(Ta=25°C)

Model No.	Radiation color	Radiation material	Power dissipation P (mW)	Forward current IF (mA)	Peak forward current IFM*1 (mA)	Derating factor (mA/°C)		Reverse voltage VR (V)	Operating temperature Topr (°C)	Storage temperature Tstg (°C)	Soldering temperature Tsol*2 (°C)
						DC	Pulse				
GM1UR55200A	Red(Super-luminosity)	GaAlAs on GaAlAs	84	30	50	0.40	0.67	5	-30 to +85	-40 to +100	350
GM1HD55200A	Red	GaAsP on GaP	84	30	50	0.40	0.67	5	-30 to +85	-40 to +100	350
GM1HY55200A	Yellow	GaAsP on GaP	84	30	50	0.40	0.67	5	-30 to +85	-40 to +100	350
GM1HS55200A	Sunset-orange	GaAsP on GaP	84	30	50	0.40	0.67	5	-30 to +85	-40 to +100	350
GM1EG55200A	Yellow-green	GaP	84	30	50	0.40	0.67	5	-30 to +85	-40 to +100	350
GM1BC55200A	Blue	GaN on SiC	86	20	50	0.27	0.67	5	-30 to +85	-40 to +100	350

\*1 Duty ratio=1/10, Pulse width=0.1ms

\*2 For 3s or less at the temperature of hand soldering. Temperature of reflow soldering is shown on the page 7.

### ■ Electro-optical Characteristics

(IF=20mA, Ta=25°C)

Lens type	Model No.	Forward voltage VF(V)		Peak emission wavelength λp(nm) TYP	Luminous intensity Iv(mcd) TYP	Spectrum radiation bandwidth Δλ(nm) TYP	Reverse current		Terminal capacitance		Page for characteristics diagrams
		TYP	MAX				IR(μA) MAX	VR(V)	Ct(pF) TYP	(MHz)	
Colorless transparency	GM1UR55200A	1.85	2.5	660	29.7	20	100	4	25	1	145
	GM1HD55200A	2.0	2.8	635	12.5	35	10	4	20	1	147
	GM1HY55200A	2.1	2.8	585	11.5	30	10	4	35	1	148
	GM1HS55200A	2.0	2.8	610	11.4	35	10	4	35	1	147
	GM1EG55200A	2.1	2.8	565	19.0	30	10	4	35	1	148
	GM1BC55200A	3.8	4.7	428	10.0	65	100	4	(60)	1	149

# LED Lamp Characteristics Diagrams

## ZG series

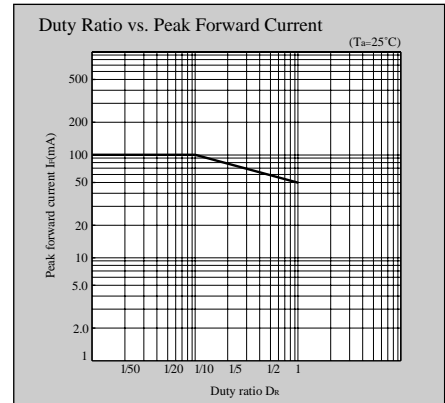
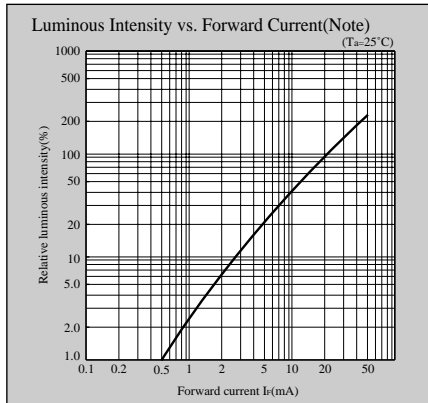
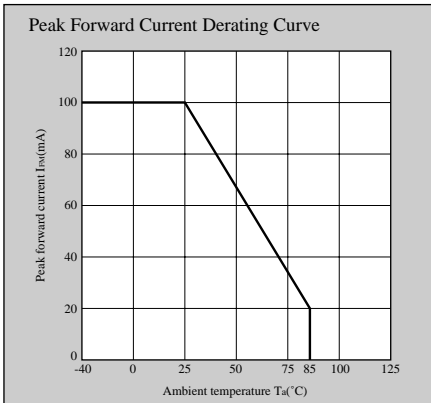
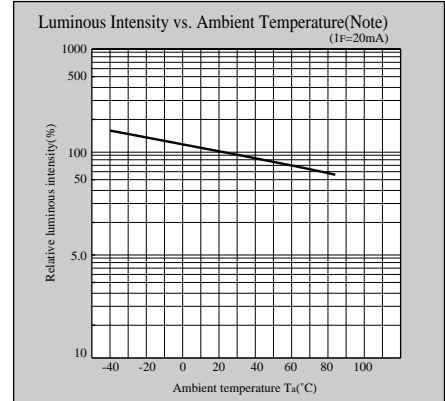
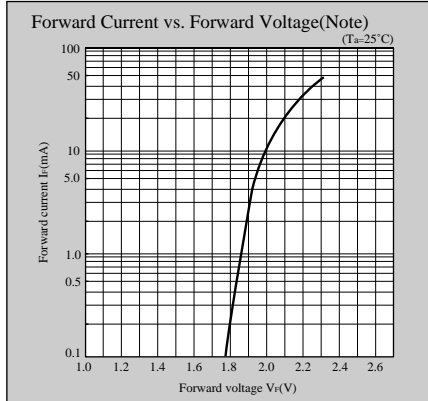
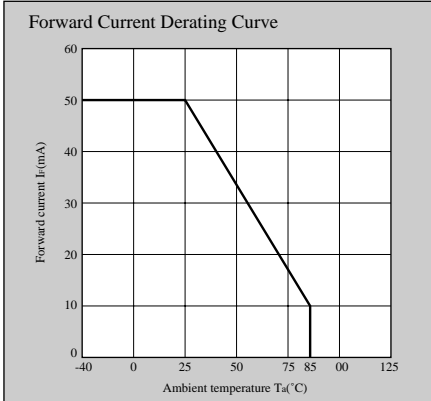

## UR,U series

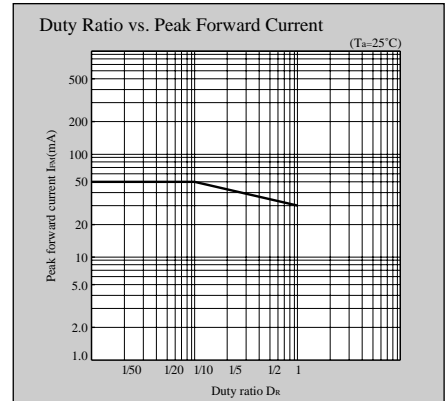
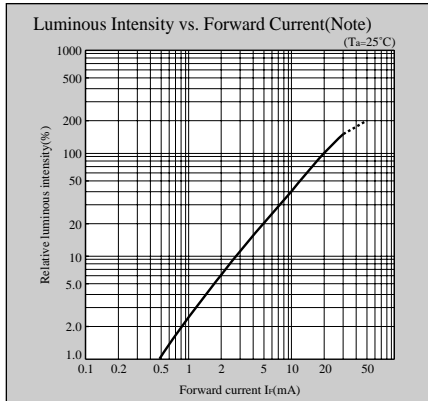
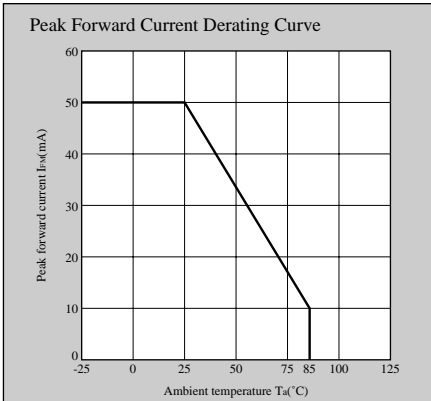
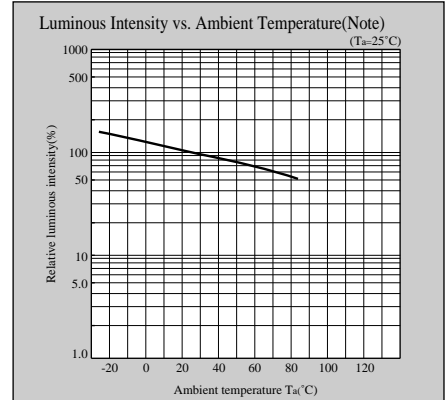
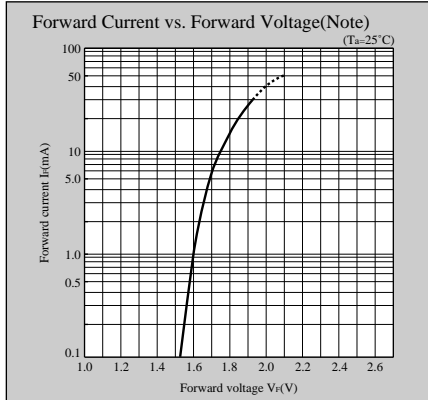
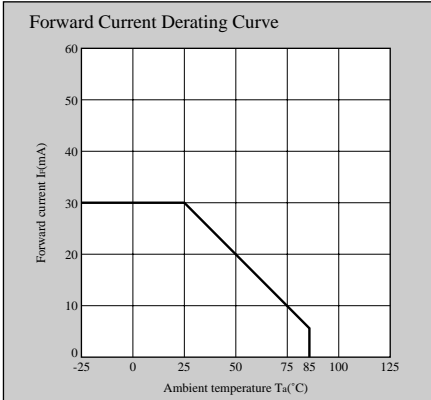

Note) Characteristics shown in diagrams are typical values. (not assurance value)

Notice In the absence of confirmation by device specification sheets, SHARP takes no responsibility for any defects that may occur in equipment using any SHARP devices shown in catalogs, data books, etc. Contact SHARP in order to obtain the latest device specification sheets before using any SHARP device.

Internet Internet address for Electronic Components Group <http://www.sharp.co.jp/ecg/>

# LED Lamp Characteristics Diagrams

## HD,D series

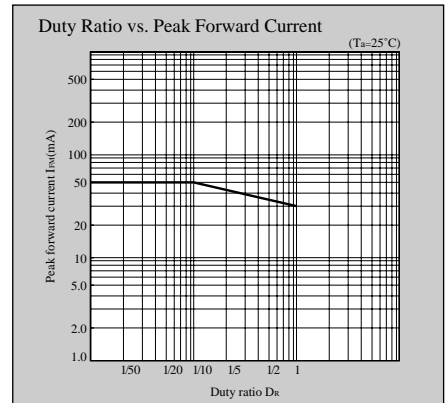
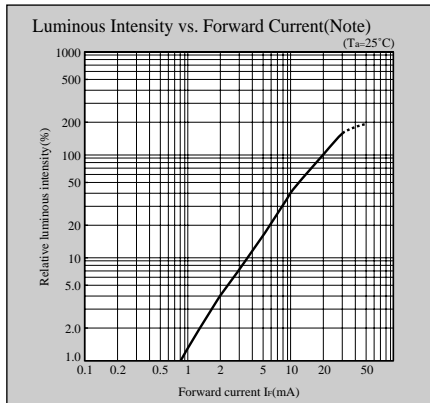
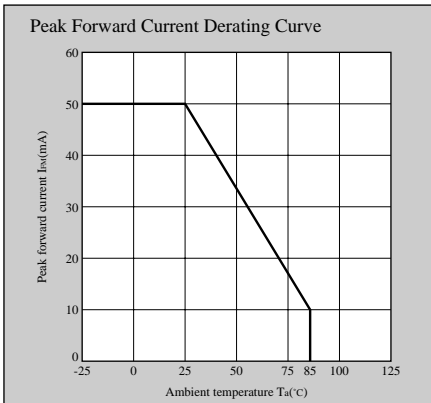
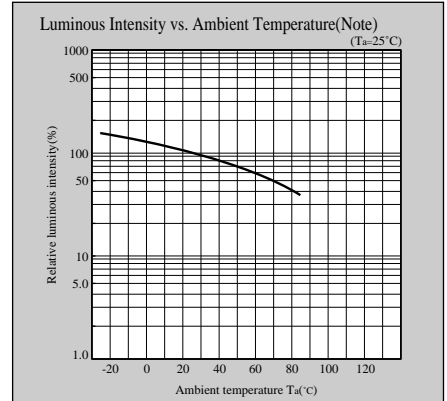
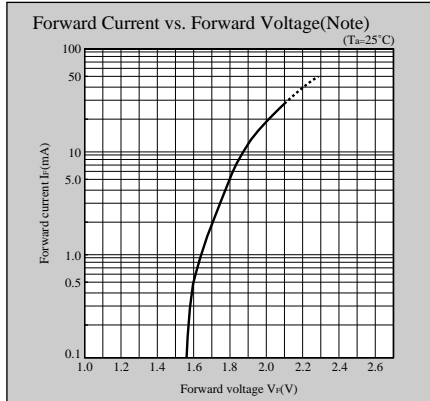
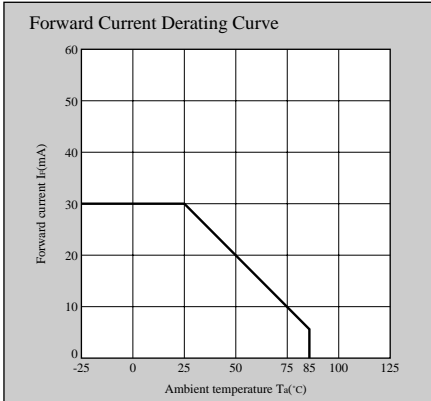

## HS,S series

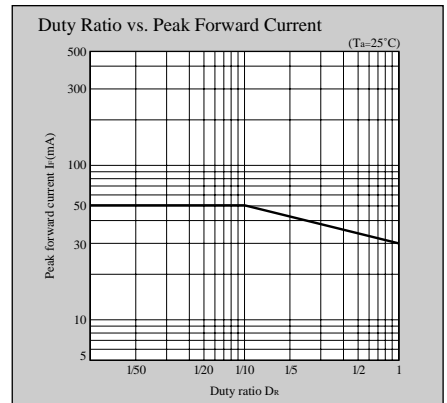
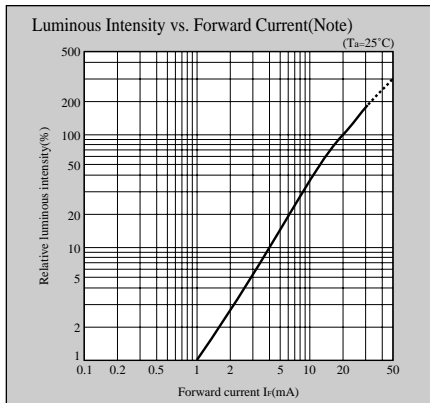
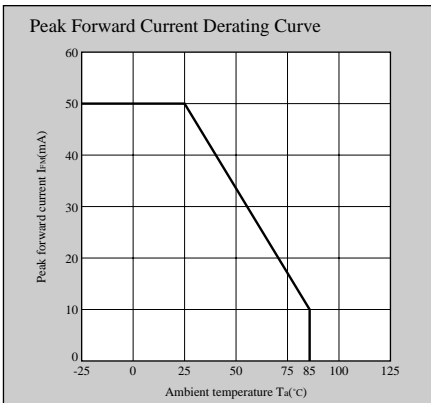
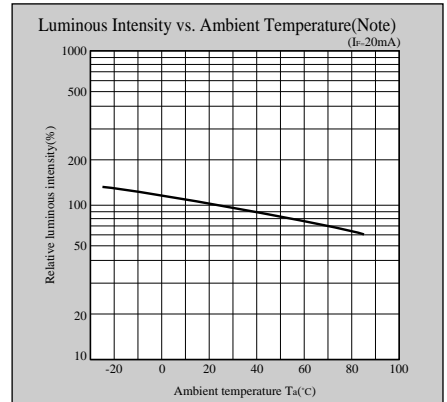
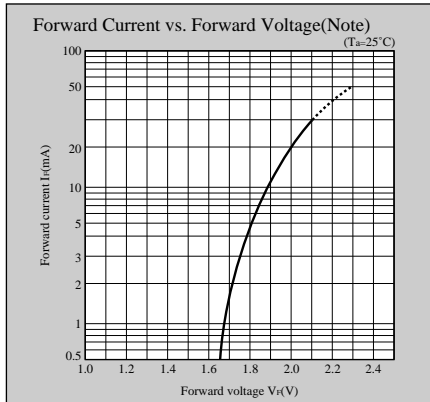
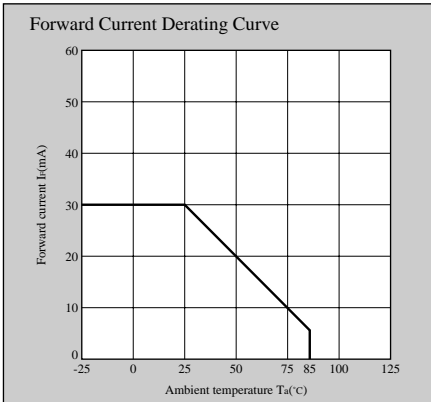

Note) Characteristics shown in diagrams are typical values. (not assurance value)

Notice In the absence of confirmation by device specification sheets, SHARP takes no responsibility for any defects that may occur in equipment using any SHARP devices shown in catalogs, data books, etc. Contact SHARP in order to obtain the latest device specification sheets before using any SHARP device.

Internet Internet address for Electronic Components Group <http://www.sharp.co.jp/ecg/>

# LED Lamp Characteristics Diagrams

## HY,H series

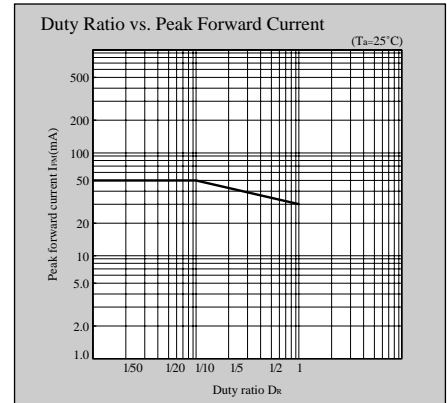
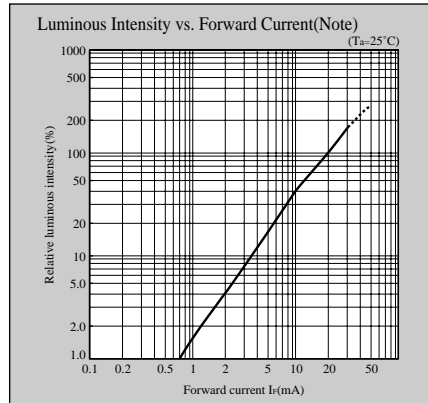
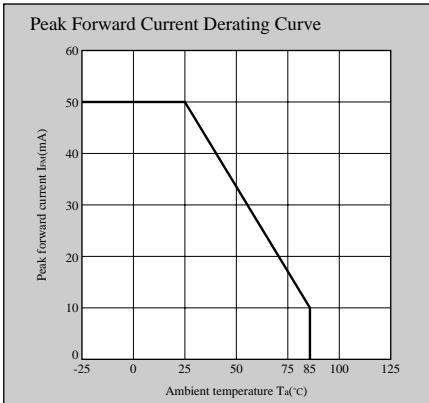
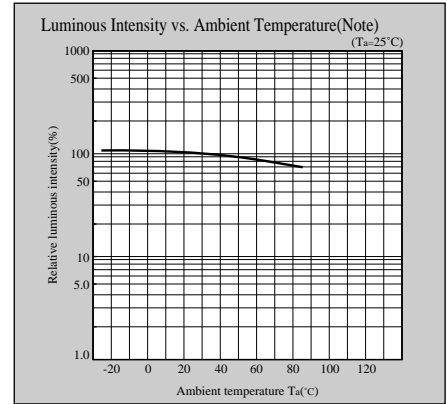
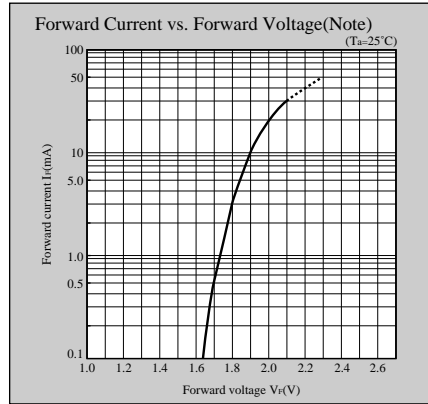
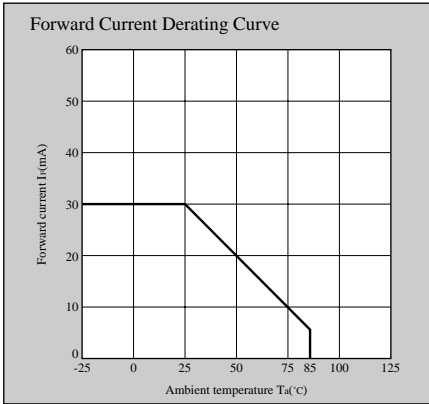

## EG,E series

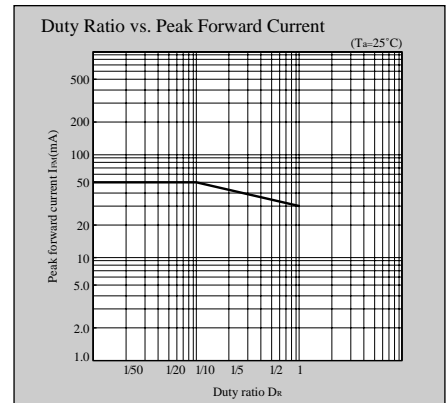
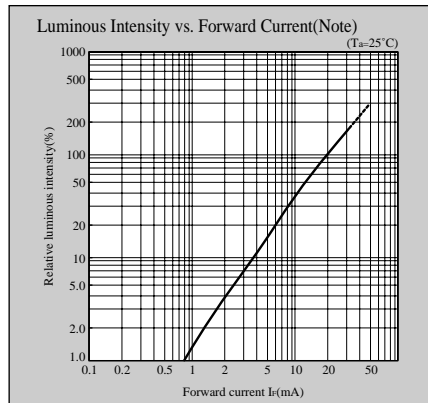
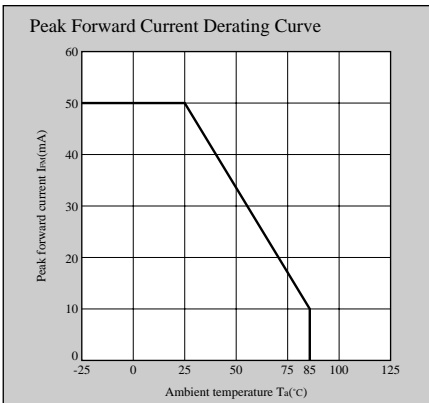
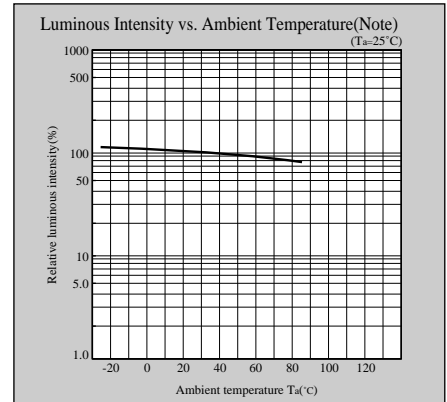
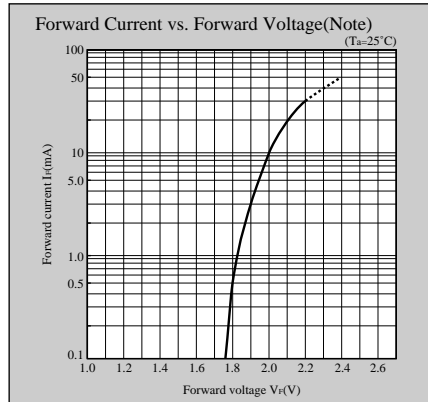
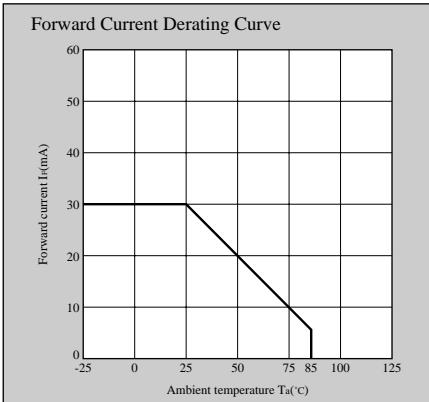

Note) Characteristics shown in diagrams are typical values. (not assurance value)

# LED Lamp Characteristics Diagrams

## KG,K series

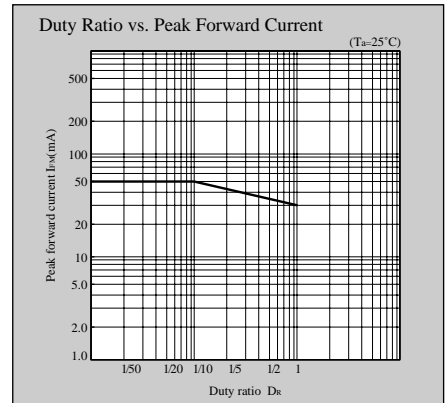
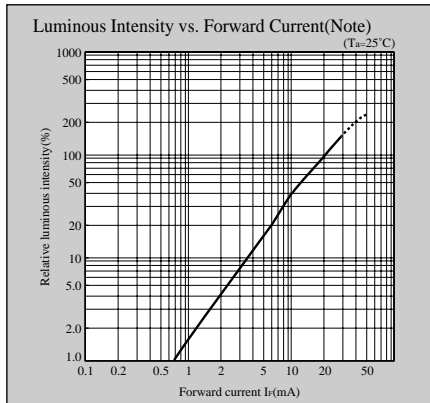
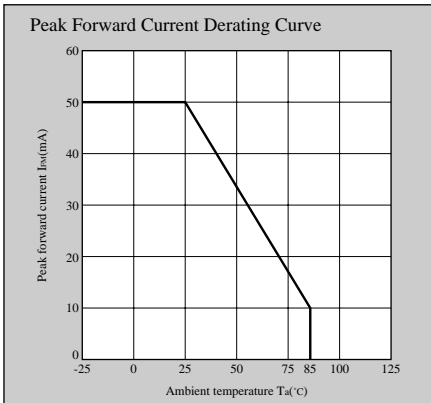
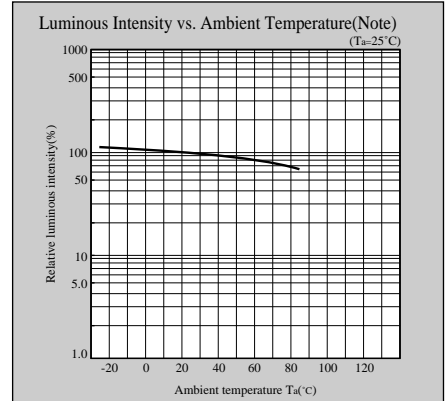
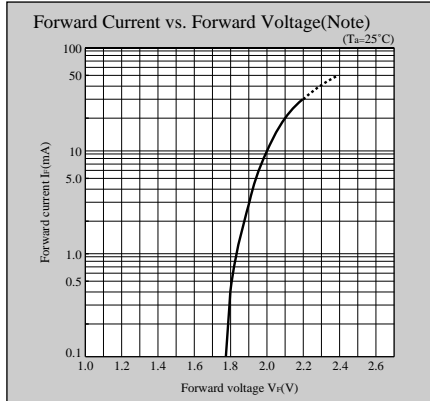
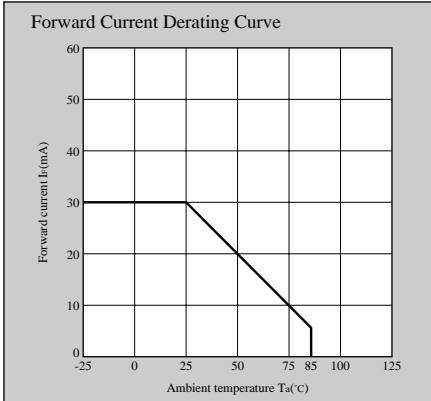

## BX,BC,B series

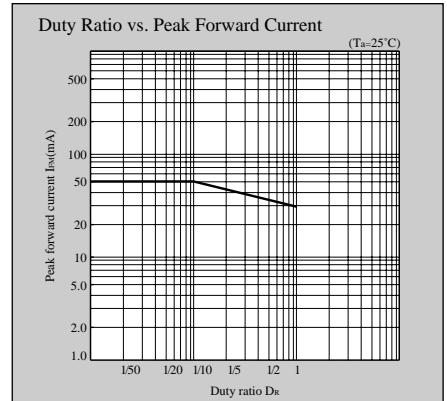
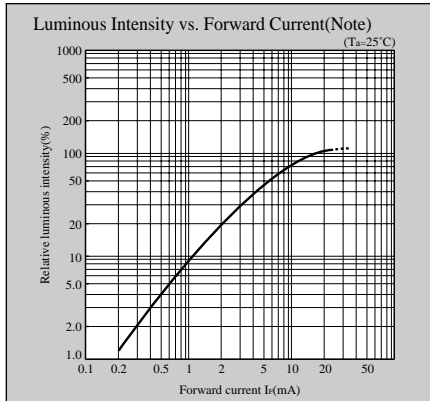
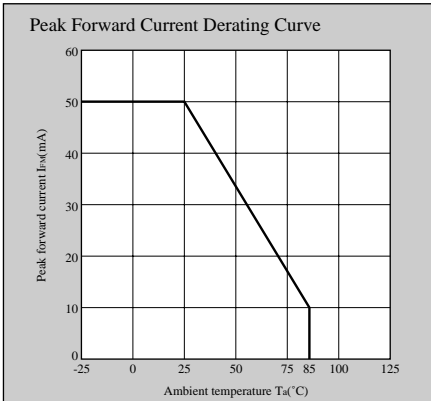
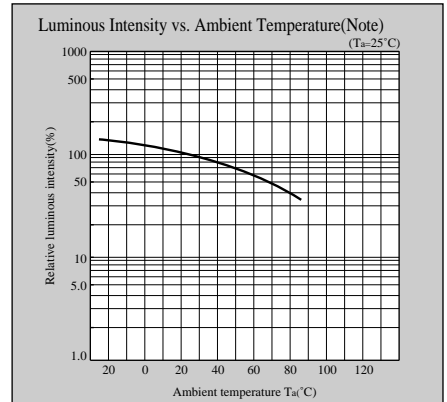
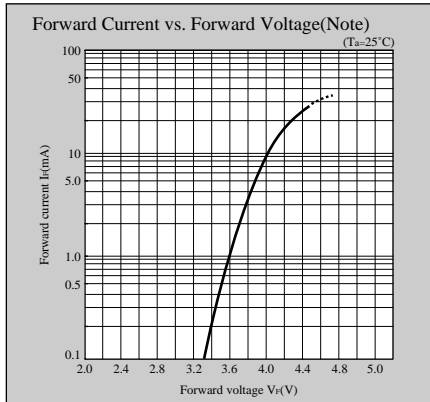
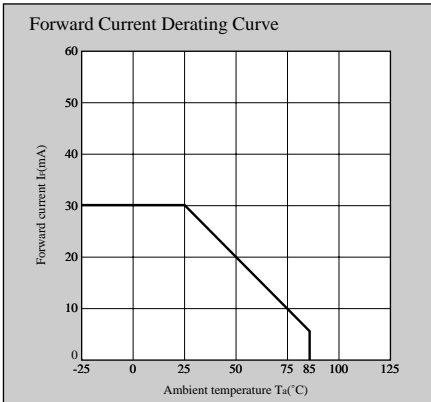

Note) Characteristics shown in diagrams are typical values. (not assurance value)

Notice In the absence of confirmation by device specification sheets, SHARP takes no responsibility for any defects that may occur in equipment using any SHARP devices shown in catalogs, data books, etc. Contact SHARP in order to obtain the latest device specification sheets before using any SHARP device.  
 Internet Internet address for Electronic Components Group <http://www.sharp.co.jp/ecg/>

# General Description of Light Emitting Diodes

## E: Chip LED Device Type

### ■ Mounting to a PWB

Design the product so that the devices will not be mounted in the same direction as the warp of the PWB.

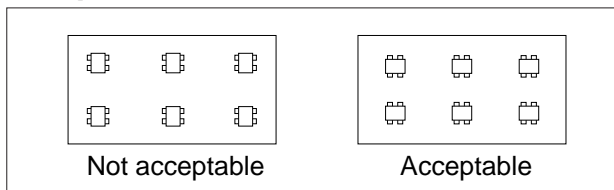

### ■ Soldering Conditions

Solder the lead pins under the following conditions.

Type of Soldering	Conditions
1. Manual soldering	300°C ± 5°C within 5 seconds
2. Reflow soldering	Preheating 100°C to 150°C within 2 minutes Soldering 245°C ± 5°C within 5 seconds Gradual cooling (Avoid quenching)

- In manual soldering, do not move the lead pins with the soldering edge.
- Avoid applying excessive solder reinforcement.
- In using surface mount type numeric LEDs, please refer to the specification sheet because conditions shall be changed.

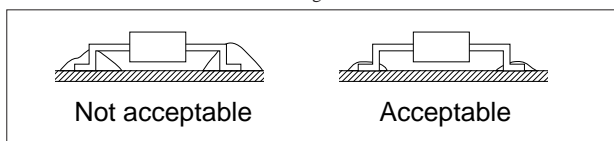

- Do not try to correct the position of the devices after soldering.
- Do not warp PWB after soldering.

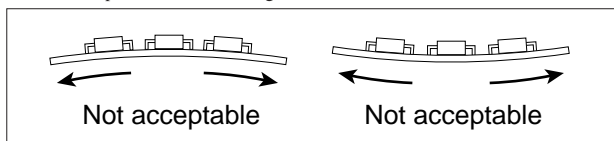

### ■ Cleaning

#### (1) Solvents

The package resin may be penetrated by solvents used in cleaning. Refer to the table below for usable solvents.

Solvent	Usable
Ethyl alcohol	○
Isopropyl alcohol	○
Chlorosen	×
Acetone	×
Trichloroethylene	×

- : Acceptable
- × : Not acceptable

(Notes) • There is a world-wide movement to restrict the use of chlorofluorocarbon (CFC) based solvents and we recommend that you avoid their use. However, before using a CFC substitute solvent, carefully check that it will not penetrate the package resin.

#### (2) Cleaning Methods

Cleaning Method	Usable	Remarks
Solvent cleaning	○	Immersion up to one minute at room temperature
Ultrasonic cleaning	△	Test the cleaning under actual conditions and check for abnormalities before actual use.

- : Acceptable
- △ : Acceptability depends on device type and conditions

(Notes) • The affect on the device from ultrasonic cleaning differs depending on the size of the cleaning bath, ultrasonic output, duration, board size and device mounting method. Test the cleaning method under actual conditions and check for abnormalities before actual use.

- Please contact our representative before using a cleaning solvent or method not given above.
- Since the device is very small, it may be damaged by excessive stress. So, pay special attention to the transport method and handling.

■ Leadless Chip LED(Unit : mm)

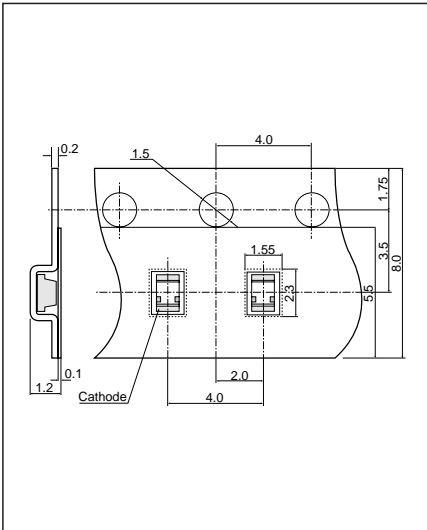

LT1□40A series 4 000 pcs. /reel

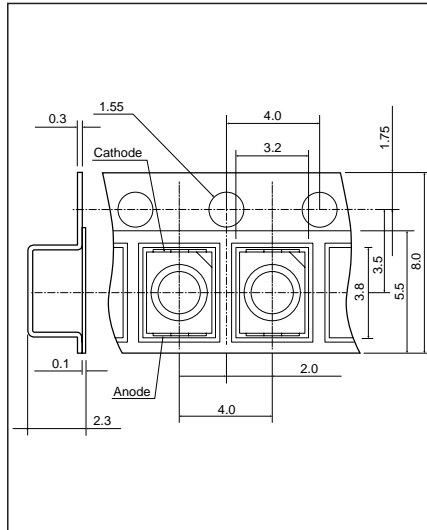

LT1Z□95 series

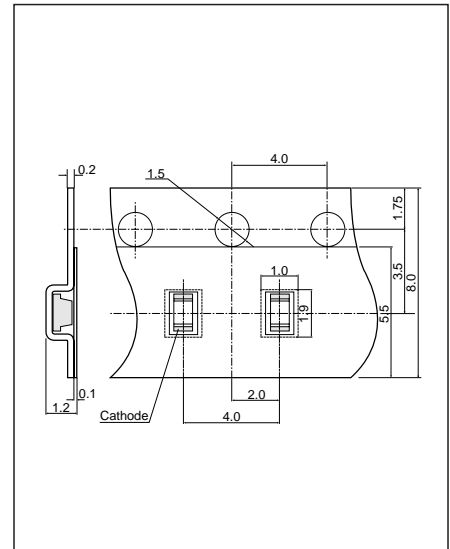

LT1□67A series 4 000 pcs. /reel

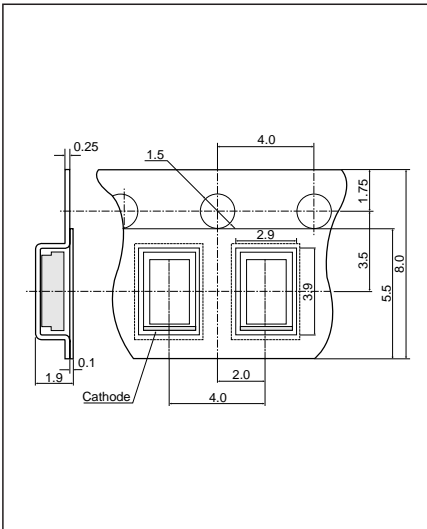

LT1□90A series 3 000 pcs. / reel

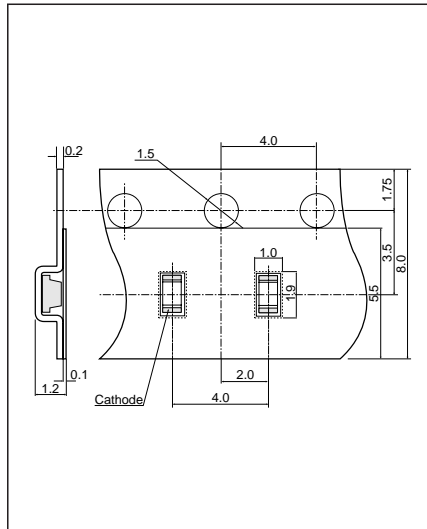

LT1□97A series 5 000 pcs. / reel

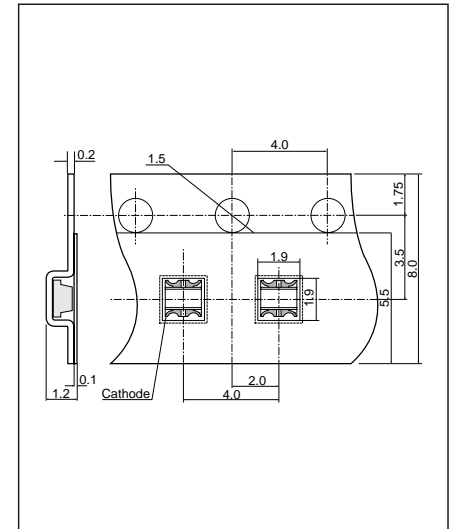

LT1□□67A series/LT1W67A 4 000 pcs. /reel

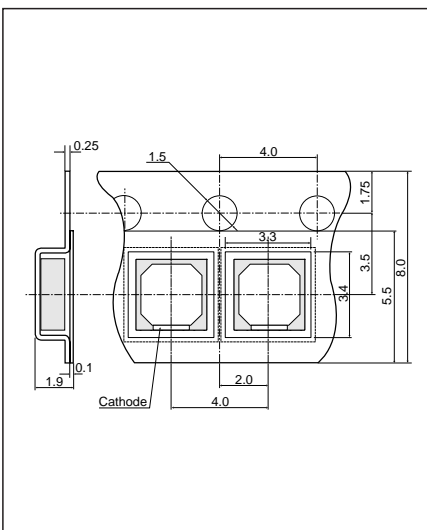

LT1□□90A series 3 000 pcs. / reel

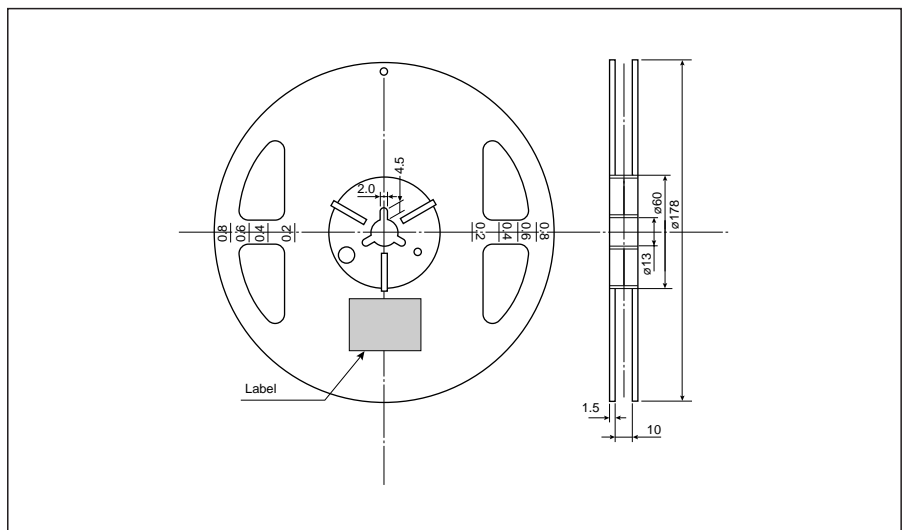

### NOTICE

- The circuit application examples in this publication are provided to explain representative applications of SHARP devices and are not intended to guarantee any circuit design or license any intellectual property rights. SHARP takes no responsibility for any problems related to any intellectual property right of a third party resulting from the use of SHARP's devices.
- Contact SHARP in order to obtain the latest device specification sheets before using any SHARP device. SHARP reserves the right to make changes in the specifications, characteristics, data, materials, structure, and other contents described herein at any time without notice in order to improve design or reliability. Manufacturing locations are also subject to change without notice.
- Observe the following points when using any devices in this publication. SHARP takes no responsibility for damage caused by improper use of the devices which does not meet the conditions and absolute maximum ratings to be used specified in the relevant specification sheet nor meet the following conditions:
  - (i) The devices in this publication are designed for use in general electronic equipment designs such as:
    - Personal computers
    - Office automation equipment
    - Telecommunication equipment [terminal]
    - Test and measurement equipment
    - Industrial control
    - Audio visual equipment
    - Consumer electronics
  - (ii) Measures such as fail-safe function and redundant design should be taken to ensure reliability and safety when SHARP devices are used for or in connection with equipment that requires higher reliability such as:
    - Transportation control and safety equipment (i.e., aircraft, trains, automobiles, etc.)
    - Traffic signals
    - Gas leakage sensor breakers
    - Alarm equipment
    - Various safety devices, etc.
  - (iii) SHARP devices shall not be used for or in connection with equipment that requires an extremely high level of reliability and safety such as:
    - Space applications
    - Telecommunication equipment [trunk lines]
    - Nuclear power control equipment
    - Medical and other life support equipment (e.g., scuba).
- Contact a SHARP representative in advance when intending to use SHARP devices for any "specific" applications other than those recommended by SHARP or when it is unclear which category mentioned above controls the intended use.
- If the SHARP devices listed in this publication fall within the scope of strategic products described in the Foreign Exchange and Foreign Trade Control Law of Japan, it is necessary to obtain approval to export such SHARP devices.
- This publication is the proprietary product of SHARP and is copyrighted, with all rights reserved. Under the copyright laws, no part of this publication may be reproduced or transmitted in any form or by any means, electronic or mechanical, for any purpose, in whole or in part, without the express written permission of SHARP. Express written permission is also required before any use of this publication may be made by a third party.
- Contact and consult with a SHARP representative if there are any questions about the contents of this publication.